

©2020 Hangzhou Hikvision Digital Technology Co., Ltd. All rights reserved.

About this Manual

The Manual includes instructions for using and managing the Product. Pictures, charts, images and all other information hereinafter are for description and explanation only. The information contained in the Manual is subject to change, without notice, due to firmware updates or other reasons. Please find the latest version of this Manual at the Hikvision website (<https://www.hikvision.com/>). Please use this Manual with the guidance and assistance of professionals trained in supporting the Product.

HIKVISION and other Hikvision's trademarks and logos are the properties of Hikvision in various jurisdictions. Other trademarks and logos mentioned are the properties of their respective owners.

Disclaimer

TO THE MAXIMUM EXTENT PERMITTED BY APPLICABLE LAW, THIS MANUAL AND THE PRODUCT DESCRIBED, WITH ITS HARDWARE, SOFTWARE AND FIRMWARE, ARE PROVIDED "AS IS" AND "WITH ALL FAULTS AND ERRORS". HIKVISION MAKES NO WARRANTIES, EXPRESS OR IMPLIED, INCLUDING WITHOUT LIMITATION, MERCHANTABILITY, SATISFACTORY QUALITY, OR FITNESS FOR A PARTICULAR PURPOSE. THE USE OF THE PRODUCT BY YOU IS AT YOUR OWN RISK. IN NO EVENT WILL HIKVISION BE LIABLE TO YOU FOR ANY SPECIAL, CONSEQUENTIAL, INCIDENTAL, OR INDIRECT DAMAGES, INCLUDING, AMONG OTHERS, DAMAGES FOR LOSS OF BUSINESS PROFITS, BUSINESS INTERRUPTION, OR LOSS OF DATA, CORRUPTION OF SYSTEMS, OR LOSS OF DOCUMENTATION, WHETHER BASED ON BREACH OF CONTRACT, TORT (INCLUDING NEGLIGENCE), PRODUCT LIABILITY, OR OTHERWISE, IN CONNECTION WITH THE USE OF THE PRODUCT, EVEN IF HIKVISION HAS BEEN ADVISED OF THE POSSIBILITY OF SUCH DAMAGES OR LOSS.

YOU ACKNOWLEDGE THAT THE NATURE OF INTERNET PROVIDES FOR INHERENT SECURITY RISKS, AND HIKVISION SHALL NOT TAKE ANY RESPONSIBILITIES FOR ABNORMAL OPERATION, PRIVACY LEAKAGE OR OTHER DAMAGES RESULTING FROM CYBER-ATTACK, HACKER ATTACK, VIRUS INSPECTION, OR OTHER INTERNET SECURITY RISKS; HOWEVER, HIKVISION WILL PROVIDE TIMELY TECHNICAL SUPPORT IF REQUIRED.

YOU AGREE TO USE THIS PRODUCT IN COMPLIANCE WITH ALL APPLICABLE LAWS, AND YOU ARE SOLELY RESPONSIBLE FOR ENSURING THAT YOUR USE CONFORMS TO THE APPLICABLE LAW. ESPECIALLY, YOU ARE RESPONSIBLE, FOR USING THIS PRODUCT IN A MANNER THAT DOES NOT INFRINGE ON THE RIGHTS OF THIRD PARTIES, INCLUDING WITHOUT LIMITATION, RIGHTS OF PUBLICITY, INTELLECTUAL PROPERTY RIGHTS, OR DATA PROTECTION AND OTHER PRIVACY RIGHTS. YOU SHALL NOT USE THIS PRODUCT FOR ANY PROHIBITED END-USES, INCLUDING THE DEVELOPMENT OR PRODUCTION OF WEAPONS OF MASS DESTRUCTION, THE DEVELOPMENT OR PRODUCTION OF CHEMICAL OR BIOLOGICAL WEAPONS, ANY ACTIVITIES IN THE CONTEXT RELATED TO ANY NUCLEAR EXPLOSIVE OR UNSAFE NUCLEAR FUEL-CYCLE, OR IN SUPPORT OF HUMAN RIGHTS ABUSES.

IN THE EVENT OF ANY CONFLICTS BETWEEN THIS MANUAL AND THE APPLICABLE LAW, THE LATER PREVAILS.



This product and - if applicable - the supplied accessories too are marked with "CE" and comply therefore with the applicable harmonized European standards listed under the EMC Directive 2014/30/EU, the RE Directive 2014/53/EU, the RoHS Directive 2011/65/EU.



2012/19/EU (WEEE directive): Products marked with this symbol cannot be disposed of as unsorted municipal waste in the European Union. For proper recycling, return this product to your local supplier upon the purchase of equivalent new equipment, or dispose of it at designated collection points. For more information see: www.recyclethis.info

INSTALLATION CAUTION



The additional force shall be equal to three times the weight of the equipment but not less than 50N. The equipment and its associated mounting means shall remain secure during the installation. After the installation, the equipment, including any associated mounting plate, shall not be damaged.



FCC Information

Please take attention that changes or modification not expressly approved by the party responsible for compliance could void the user's authority to operate the equipment. FCC compliance: This equipment has been tested and found to comply with the limits for a Class B digital device, pursuant to part 15 of the FCC Rules. These limits are designed to provide reasonable protection against harmful interference in a residential installation. This equipment generates, uses and can radiate radio frequency energy and, if not installed and used in accordance with the instructions, may cause harmful interference to radio communications. However, there is no guarantee that interference will not occur in a particular installation. If this equipment does cause harmful interference to radio or television reception, which can be determined by turning the equipment off and on, the user is encouraged to try to correct the interference by one or more of the following measures:

- Reorient or relocate the receiving antenna.
 - Increase the separation between the equipment and receiver.
 - Connect the equipment into an outlet on a circuit different from that to which the receiver is connected.
 - Consult the dealer or an experienced radio/TV technician for help.
- This equipment should be installed and operated with a minimum distance 20cm between the radiator and your body.

FCC Conditions

This device complies with part 15 of the FCC Rules. Operation is subject to the following two conditions:

1. This device may not cause harmful interference.
2. This device must accept any interference received, including interference that may cause undesired operation.



replacement of a battery with an incorrect type that can defeat a safeguard (for example, in the case of some lithium battery types);

- disposal of a battery into fire or a hot oven, or mechanically crushing or cutting of a battery, that can result in an explosion;
- leaving a battery in an extremely high temperature surrounding environment that can result in an explosion or the leakage of flammable liquid or gas; and
- a battery subjected to extremely low air pressure that may result in an explosion or the leakage of flammable liquid or gas



2006/66/EC (battery directive): This product contains a battery that cannot be disposed of as unsorted municipal waste in the European Union. See the product documentation for specific battery information. The battery is marked with this symbol, which may include lettering to indicate cadmium (Cd), lead (Pb), or mercury (Hg). For proper recycling, return the battery to your supplier or to a designated collection point. For more information see: www.recyclethis.info

BATTERY CAUTION



replacement of a battery with an incorrect type that can defeat a safeguard (for example, in the case of some lithium battery types);

- disposal of a battery into fire or a hot oven, or mechanically crushing or cutting of a battery, that can result in an explosion;
- leaving a battery in an extremely high temperature surrounding environment that can result in an explosion or the leakage of flammable liquid or gas; and
- a battery subjected to extremely low air pressure that may result in an explosion or the leakage of flammable liquid or gas

Chemical burning danger

Do not swallow the battery. Keep new and used batteries away from the children. If you think batteries might have been swallowed or placed inside any part of the body, seek immediate medical attention.

Risk of explosion if battery is replaced by an incorrect type.

Replacement of a battery with an incorrect type that can defeat a safeguard.

Dispose of used batteries according to the instructions and local regulation.

If the battery compartment does not close securely, stop using the product and keep it away from children.

1 Appearance

Test/Hush Button

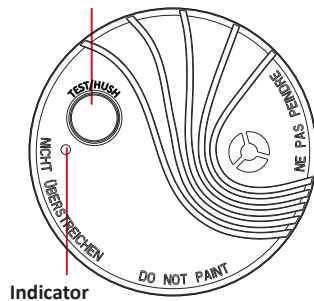

Power Switch

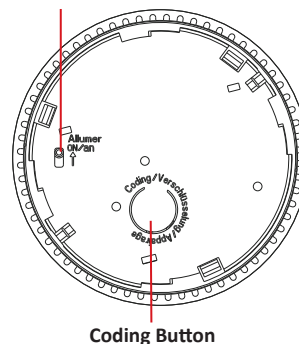

2 Function

Audible and Visual Alarm Indicators

When operating normally, a red LED adjacent to the Test button will flash every 320 s. When smoke is detected, an internal sounder will activate to alert occupants, and the LED will flash rapidly. The sounder is a loud, pulsating alarm and produces a repeating Temporal 3 audible signal pattern (0.5 s on, 0.5 s off for 3 cycles, followed by 1.5 s off, repeating).

Test/Hush Button When there is no alarm present, hold the Test/Hush button will activate the smoke alarm to check its operation. The alarm will sound and the LED will flash rapidly. The unit will return to normal condition in about 10 s when the test is completed.

When the smoke alarm is in the Alarm condition, press the Test/Hush button will hush the smoke alarm for approximately 11 min. The Hush feature should only be used after the cause of the alarm is known (such as normal cooking fumes). The Hush feature allows time for the smoke to clear. During the hush time, the LED will flash twice every second. After the Hush time has expired, the smoke alarm will return to normal sensitivity. If smoke is still present in the unit, the alarm will re-activate. The Hush feature can be used repeatedly.

Smoke Chamber Fault

The detector monitors the condition of the smoke sensing chamber. If the smoke sensing chamber ceases to operate normally, the smoke alarm will emit a short audible signal, then followed by a single Red LED indicator flash, repeating every 40 s. In this case, try vacuuming clean the detector to remove dust. If the condition persists, replace the detector with a new unit.

Low Battery

When the battery is depleted, the detector will emit a short audible signal and the Red LED indicator flash, repeating every 40 s for at least 30 days. Interconnected detector will also emit two short audible signals and the Red LED indicator will flash twice, repeating every 4 hours. When the Low Battery signal is given, replaced the detector with a new unit.

Interconnection

Wireless interconnection allows up to 12 detectors to be connected together. Interconnected detector will activate sounders on all units if any smoke alarm detector. In this case, only the detector that detected smoke will flash the Red LED. This allows the home owner to quickly locate the cause of the alarm.

Local alarm memory

After alarm occurs, the green LED gives 3 flashes every 40 s up to 24 h, which stops flashing after 24 hours. Any time before the next alarm, press the Test button, the detector shall emit 3 audible beeps every 1 s. Release of the Test button shall reset the alarm.

3 Enrollment

1 Enroll the Detector Locally

1. Log in the Hik-ProConnect, and select a site.
2. Select the AX PRO in the site.
3. Enter "Settings-System Settings", and tap the "Enrollment Mode" button to make the AX PRO enter the enrollemnt status.
4. Turn the power switch of the peripheral on to enrolled it to the control panel.

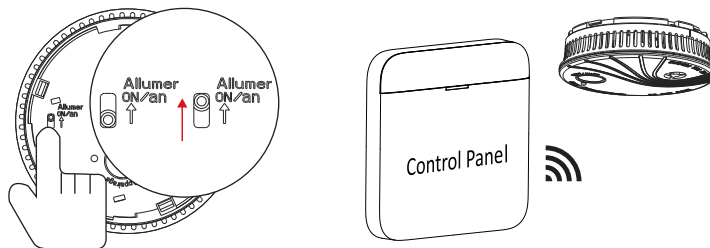

2 Register the Detector via APP

1. Log in the Hik-ProConnect, and select a site.
2. Select the AX PRO in the site.
3. Tap the "+" icon on the bottom of the page, and scan the QR code to add the peripheral.
4. Turn the power switch of the peripheral on, and it will be automatically enrolled to the control panel.

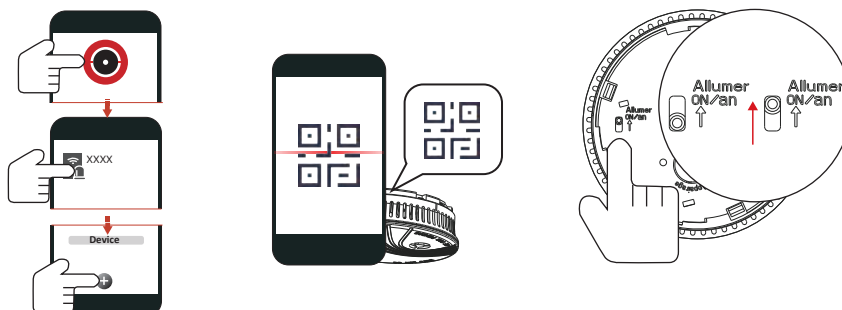

3 Format

Hold the coding button and power the detector on at the same time. The detector will be formatted after 8 s.

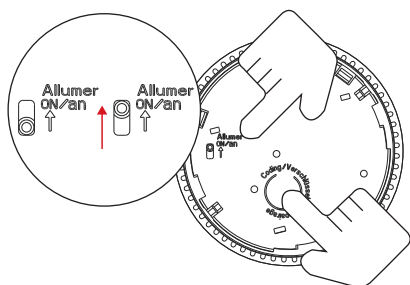

4 Installation

1 Equipment

Before commencing installation, ensure all equipment and tools to mount and test the device are available, such as drills, mounting screws (supplied), cables and ladders.

2 Location Selection

⚠ Location and number of smoke alarms may be specified in relevant regulations. Where these do not exist, the requirements of DIN 14676 can be used. According to German application standard DIN 14676

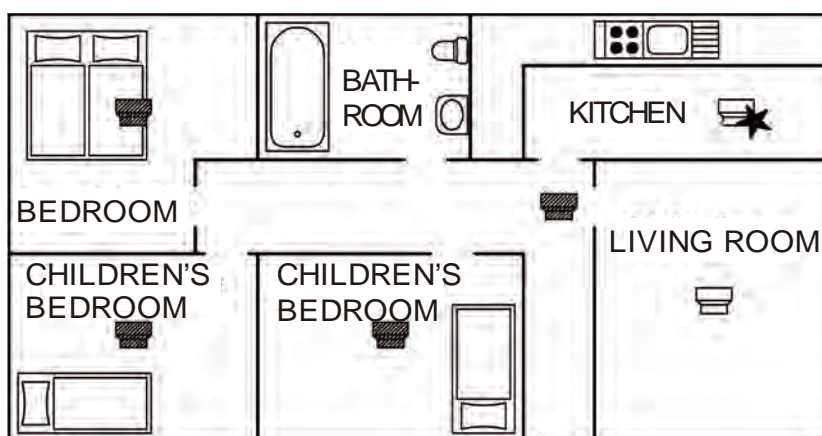

Figure 1 a) Example of the application in a flat

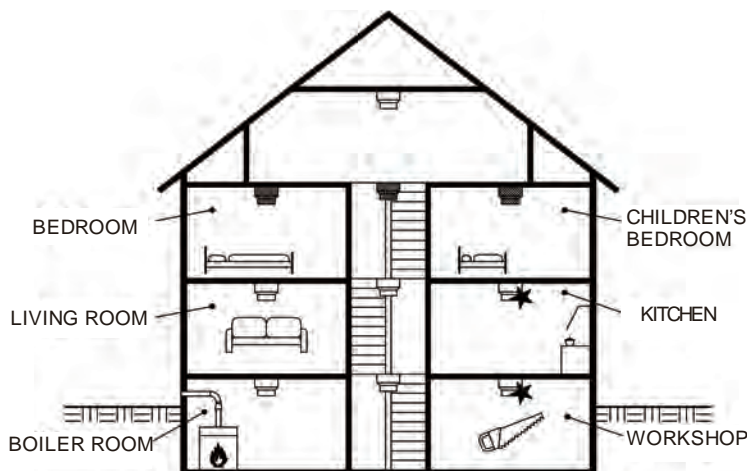

Figure 1 b) Example of the application in a typical single-family house

▨ Smoke alarm are to be used as minimum requirement in all bedrooms, children's rooms and hallways which act as escape routes, and are to be installed in each case in the middle of the room, on the ceiling only (do not install on wall).

Select the installation location with a minimum distance of 50 cm to surrounding walls, furniture and lamps.

☐ Configuration is optimal when devices are also located in all other rooms as well as staircases.

★ In kitchens and wet rooms, smoke alarms are only used when false alarm caused by the characteristics of these space are excluded. Please observe the graphics in this guide.

Installation Location

Install smoke alarms as close to the centre of the ceiling as possible, away from light fittings and air-conditioning ducts. If this is not practical, put the alarm on the ceiling, no closer than 50 cm from any wall or corner.

Rooms with sloped ceiling

In rooms with ceiling slopes $> 20^\circ$, the smoke alarm shall be mounted at least 0.5 m and not more than 1 m away from the ceiling peak.

Ceilings with a slope angle $\leq 20^\circ$ should be treated as horizontal ceiling.

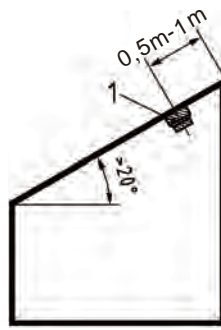

Figure 2 Mounting for ceiling with slope > 20°

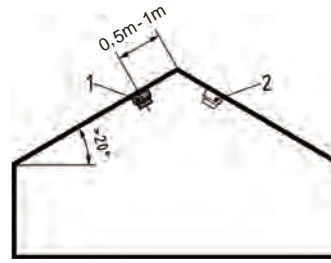

Figure 3 Mounting for gabled ceiling with slope > 20°

Install the smoke alarm in either left position or right position.

- 1-Smoke alarm in the left position
- 2-Smoke alarm in the right position

In rooms with sloping ceilings that is prorated, if the horizontal ceiling is ≤ 1 m wide, mount the smoke alarm as shown in *Mounting for gabled ceiling with slope > 20°*. If the horizontal ceiling > 1 m wide, mount the smoke alarm in the centre on the horizontal ceiling as shown in *Mounting in rooms with sloping ceiling and horizontal ceiling*.

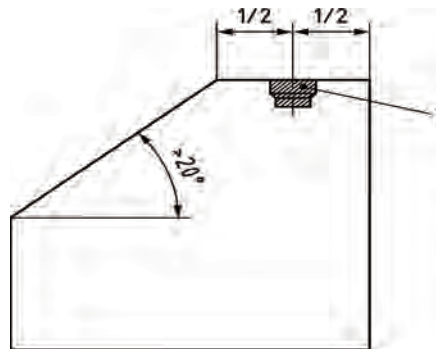

Figure 4 Mounting in rooms with sloping ceiling and horizontal ceiling

Where Not to Install the Smoke Detector

Nuisance alarms occur when smoke alarms are installed where they will not work properly. To avoid nuisance alarms, do not install smoke alarms in the following situations.

- In or near areas where combustion particles are present, such as kitchens with few windows or poor ventilation, garages where there may be vehicle exhaust, near furnaces, combustion heaters, and space heaters. Combustion particles are the by-products of something that is burning, which the smoke alarm may detect.
- Within 6 m of kitchens where combustion particles are normally present. If a 6 m distance is not possible, e.g. in a mobile home, try to install the smoke alarm as far away from the combustion particles as possible. Ensure the area is well ventilated.
- In dead-air areas, where ventilation systems cause air-flow that would not pass through the smoke alarm sensing chamber. Avoid also air-flow from areas where normal combustion particles are expected, such as kitchens.

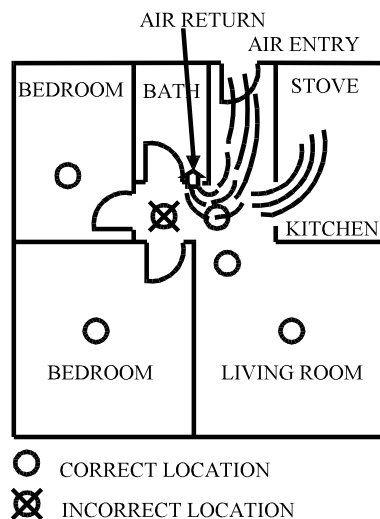

Figure 5 Mounting in rooms with sloping ceiling and horizontal ceiling

- In damp or very humid areas, or within 3 m of bathrooms with showers. Moisture in humid air can enter the sensing chamber, then condense into droplets upon cooling, which can cause nuisance alarms.
- In very cold or very hot areas, including unheated buildings or outdoor rooms. If the temperature rises above or falls below the operating range of smoke alarm, it may not function properly. The temperature range for your smoke alarm is -10 °C ~ 60 °C.
- In very dusty or dirty areas. Dirt and dust can build up on the smoke alarm's sensing chamber, to make it overly sensitive. Additionally, dust or dirt can block openings to the sensing chamber and limit the smoke alarm from sensing smoke.
- Near fresh air vents or high draft areas like air conditioners, heaters or fans, fresh air vents and drafts, which can drive smoke away from smoke alarms.
- In dead air spaces, which are often at the top of a peaked roof or in apex of ceilings and walls. Dead air may prevent smoke from reaching a smoke alarm. See Fig. 2, Fig. 3, Fig. 4 and Fig. 5 for recommended mounting location.
- In insect-infested areas. If insects enter a smoke alarm's sensing chamber, they may cause a nuisance alarm. Where insects are a problem, get rid of them before installing the smoke alarm.
- Near fluorescent lights. Electrical "noise" from fluorescent lights may cause nuisance alarms. Do not install smoke alarms within 1.5 m of such lights.

3 Mounting

1. Check the signal strength.

Tap the **Signal Strength Test** in the Hik-ProConnect to enter the mode and tap the test button:
 Solid green for 3 s - Strong Signal
 Flashing green for 3 s - Medium Signal
 Solid red for 3 s - Weak Signal
 Flashing red for 3 s - Failure

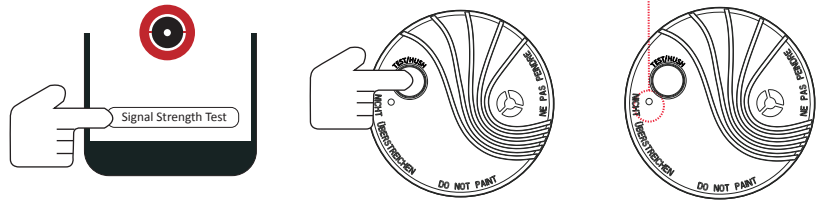

Mounting with Screws

1. Draw a 150 mm line at the required place.
2. Rotate the mounting bracket counter-clockwise and remove it from the detector.
3. Align the two longest hole slots with the drawn line. Draw a mark in each of keyhole slots.
4. Drill two 5 mm (3/16-inch) holes at the marks and insert the plastic mounting plugs (supplied).
5. Attach the bracket to the ceiling with the screws supplied.
6. Align the slot of the bracket with the detector, push the detector onto the mounting bracket, and rotate it clockwise to finish the mounting.

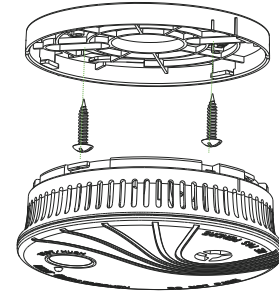

Mounting with Sponge Tape

1. Paste the sponge tape on the rear side of the detector.
2. Tear off the film.
3. Paste the detector on the required place.

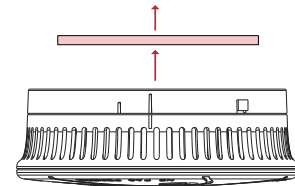

4 Test

Press and hold the Test/Hush button, and the buzzer and LED will indicate the alarm.

⚠ WARNING: The smoke alarm has a loud alarm signal. Use hearing protection when testing smoke alarms.

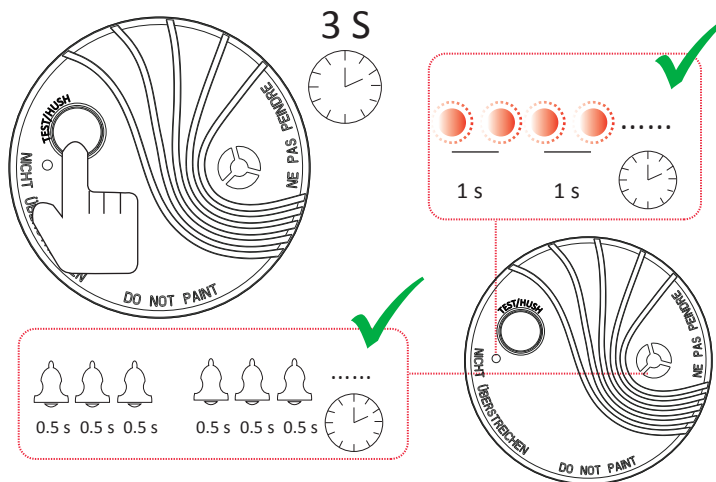

5 Interconnect Function Configuration

Up to 12 smoke detectors can be interconnected, with a typical distance of 30 m indoors and 100 m in free space. Interconnection range depends on the building construction, and is influenced by the building structure and any intervening structures that may absorb or reflect radio signals.

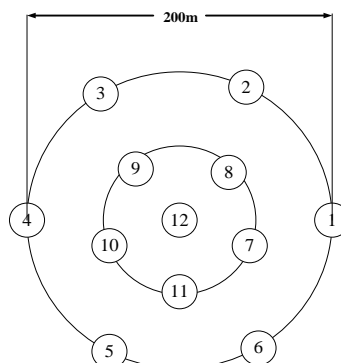

Interconnection limitations

r = 100 m in free space, 30 m indoors (depending on construction and obstructions)

1. Turn on the power switch on the bottom of the first detector.

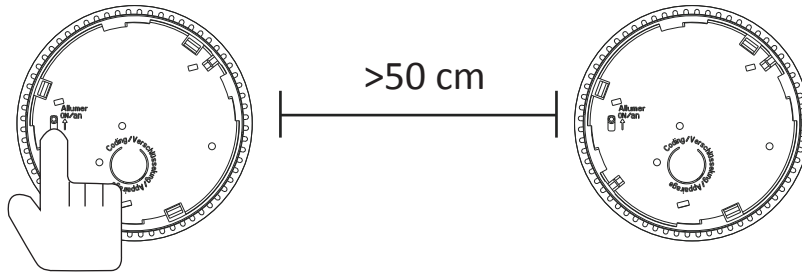

2. Short press down the coding button on the bottom of the first detector, the red LED flashes slowly, approximately once every one second. Release the button then. Notice pressing the coding button again will end the coding process.

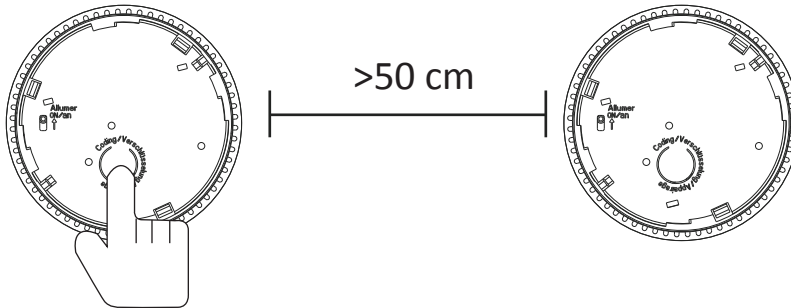

3. Turn on the power switch on the bottom of the second detector.

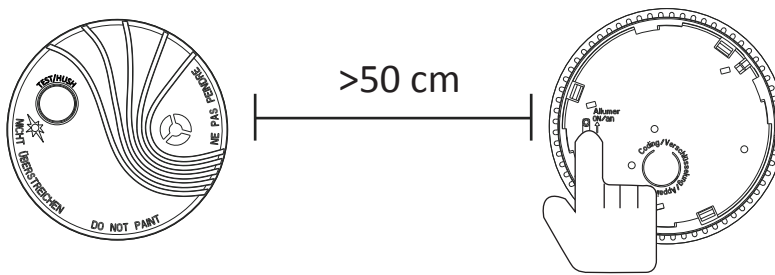

4. Short press down the coding button on the bottom of the second detector, the red LED flashes slowly, approximately once every one second. Then release the button.

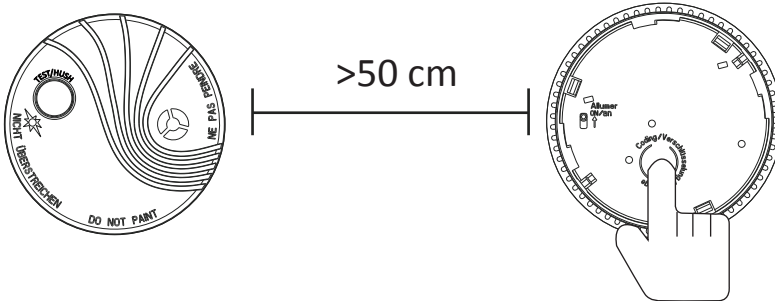

5. wait and see...

At this time, the two detectors are in the coding mode. The period of coding is about 60 seconds.

If two green LEDs of the detectors are illuminated at the same time, no flashing, which indicates that two detectors have built a new wireless interconnection, the coding is successful. Otherwise, after 60 seconds, two detectors will exit the coding mode automatically, please do it again. Please notice repeated press of coding button will also end the coding process.

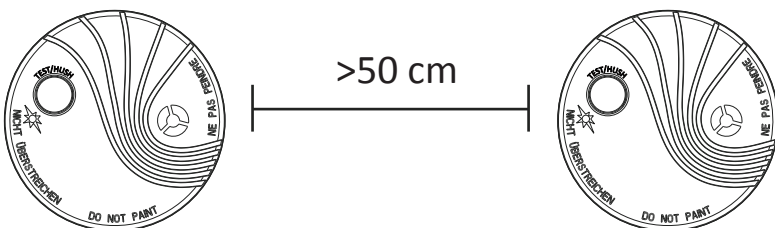

6. To connect another smoke detector. Repeat above steps. First, choose the new smoke alarm you want to add. Then choose a smoke alarm already interconnected. The new smoke alarm shall join the existing network. Repeat the above steps for other interconnected smoke alarms (up to 12).

7. Once all smoke alarms are interconnected, press the Test/Hush on each smoke alarm, and check the smoke alarm sounder operates on all interconnected smoke alarms.

8. Check that the red LED adjacent to the Test/Hush button operates only on the smoke alarm being tested.

 Smoke detectors should be interconnected within only one family residence. Otherwise, you might encounter nuisance alarms when a smoke detector is operated or tested in another residence.

6 Operations

Once installed and tested, the detector will immediately start monitoring for smoke. If the sounder in the detector operates, check for a fire and execute your safety plan.

If the detector was caused by a nuisance situation, open a window or fan the air to remove the smoke or dust from within the smoke detector. The detector will turn off as soon as the air is completely clear. Do not disconnect the battery to silence the smoke detector.

Hush

 Before using the Hush feature, identify the source of smoke and be certain that safe conditions exist.

If investigation shows the alarm signal is likely caused by a known nuisance source (such as cooking fumes), the Test/Hush button can be pressed to silence the smoke alarm for 11 min.

After the Hush time has expired, the smoke alarm will return to normal sensitivity. If smoke is still present, the alarm will be re-activated. The Hush feature can be used repeatedly.

7 Care and Maintenance

Weekly Tests

1. Press and hold the Test/Hush button on each smoke alarm.
2. Check the smoke detector sounder operates with a loud audible signal pattern (0.5 s on, 0.5 s off for 3 cycles, followed by 1.5 s off, repeating) sound, and the red LED adjacent to the Test/Hush button flashes twice every second.
3. For interconnected smoke detectors, check the smoke detector sounder operates on all interconnected detector and the red LED adjacent to the Test/Hush button operates only on the smoke detector being tested. Repeat the test on all interconnected smoke alarms.

 Never use a naked flame of any kind to test your smoke alarm. You may set fire to and damage the smoke alarm, as well as your home. The built-in Test/Hush button accurately tests all alarm functions.

Annual Maintenance

1. Vacuum or carefully wipe the cover of the smoke detector to remove any dust, lint or dirt around the openings of the smoke detector. Do not spray aerosols into the smoke detector.
2. After annual maintenance, test all smoke detectors.

Low Battery Alert

When the battery is depleted, the smoke detector will emit a short audible signal, and the LED indicator will flash once every 40 s for at least 30 days. When the low battery signal is given, change the smoke detector without delay. The battery is not user-replaceable.

Low Battery Alert With Interconnected Smoke Alarms

Where smoke detectors are connected together and a Low Battery Alert occurs on any individual unit, other interconnected smoke detectors will emit a double beep and the LED a double flash signal 4 hours after the initial low battery warning. The signals will repeat every 4 hours.

Smoke Chamber Fault

If a Smoke Chamber Fault occurs, vacuum the cover of the smoke detector to remove any dust, lint or dirt around the openings. If the fault continues, replace the smoke detector.

8 Protection From Fire

Installing smoke alarms is only one step in protecting your family from fires. You should also reduce the chances that fires will start in your home and you must increase your chances of escaping safely if one does start. The following information will help you develop a fire safety program.

1. Install smoke alarms properly. Carefully follow all the instructions in this manual. Keep your smoke alarms clean, and test them every week.
2. Non-working smoke alarms will not alert you. Replace your smoke alarms immediately if they are not working properly.
3. Follow fire safety rules, and prevent hazardous situations:
 - Use smoking materials properly. Never smoke in bed.
 - Keep matches and cigarette lighters away from children.
 - Store flammable materials in proper containers. Never use them near open flames or sparks.
 - Keep electrical appliances in good condition. Do not overload electrical circuits.
 - Keep stoves, fireplaces, chimneys, and barbecue grills grease free. Make sure they are properly installed and away from any combustible materials.
 - Keep portable heaters and open flames such as candles away from combustible materials.
 - Do not allow rubbish to accumulate.
 - Keep a supply of extra batteries on hand for your battery powered smoke alarms.

Prepare and practice a family escape plan. Review the following with your children each time you have fire escape drills. This will help everyone remember them in case of a real fire emergency.

1. Don't panic and stay calm. Your safe escape may depend on thinking clearly and remembering what you have practiced.
2. Get out of the house as quickly as possible. Follow a planned escape route. Do not stop to collect anything or to get dressed.
3. Feel the doors to see if they are hot. If they are not, open them carefully. Do not open a door if it is hot. Use an alternate escape route.
4. Stay close to the floor. Smoke and hot gases rise.
5. Cover your nose and mouth with a wet or damp cloth. Take short, shallow breaths.
6. Keep doors and windows closed. Open them only if you have to in order to escape.
7. Meet at your planned meeting place after leaving the house.
8. Call the Fire Service as soon as possible from outside your house. Give the address and your name.
9. Never go back inside a burning building.
10. Contact your local Fire Service. They will give you more ideas about how to make your home safer from fires and how to plan your family's escape.

9 Indication Description

Condition	Sounder Indication	Red LED	Green LED
Normal	Off	1 flash every 320 s	
Alarm	0.5 s on, 0.5 s off for 3 cycles, then 1.5 s off (repeating until manual hush or smoke dissipated)	2 flashes every 1 s	
	For other interconnected smoke alarms: 0.5 s on, 0.5 s off for 3 cycles, then 1.5 s off (repeat 3 times)	For other interconnected smoke alarms: Off	
Test	0.5 s on, 0.5 s off for 3 cycles, then 1.5 s off (repeating)	2 flashes every 1 s	
	For other interconnected smoke alarms: 0.5 s on, 0.5 s off for 3 cycles, then 1.5 s off (repeating)	For other interconnected smoke alarms: Off	
Hush	Off	2 flashes every 1 s	
Smoke chamber fault	1 audible beep every 40 s (separately to the LED)	1 flash every 40 s (separately to the sounder)	
Low battery	For the smoke alarm with the depleted battery: 1 audible beep every 40 s (synchronously with the LED)	For the smoke alarm with the depleted battery: 1 flash every 40 s (synchronously with the sounder)	
	For other interconnected smoke alarms: 2 audible beeps every 4 h (synchronously with LED)	For other interconnected smoke alarms: 2 flashes every 4 h (synchronously with sounder)	
Coding in progress	Off	1 flash every 1 s up to 60 s	
Coding successful	1 short beep	Off	On for 10 s
Local alarm memory	Any time before the next alarm, press the Test button, 3 audible beeps every 1 s		3 flashes every 40 s up to 24 h
	Release of the Test button shall reset the alarm		
End-of-life	3 audible beeps every 40 s		
Factory default settings	1 audible beep	2 flashes every 1 s	

10 Specification

Detection Method	Chamber With Photoelectric Sensor
Environment Temperature Indicator	Support
Signal Strength Indicator	Support
Power Switch	Power Up Enrolling
LED Indicator	Red (Alarm)
Buzzer	≥ 85dB @ 3 m
Transmission Method	Two-Way RF Wireless
Transmission Frequency	433 MHz
Transmission Security	AES-128 Encryption
Transmission Range(Free Space)	800m
Enrolling Method	Power up,Remote ID,QR Code
Power Supply	Battery Powered
Battery Type	Non Replaceable CR17450 x 1
Typical Voltage	3V
Standard Battery Life	10 Years
Operation Temperature	-10 °C to 60 °C (14 °F to 140°F)
Storage Temperature	-20 °C to 60 °C (-4 °F to 140 °F)
Operation Humidity	10% to 90%
Dimension(WxHxD)	φ102 × 35mm
Weight	125g
Mounting Method	Ceiling
Application Scenario	Indoor

Version: 1.0
2020-12-30